

Empower Your Enterprise with Agent-Native AI

Turn your existing software, websites, and workflows into an autonomous AI workforce—without rebuilding your systems.

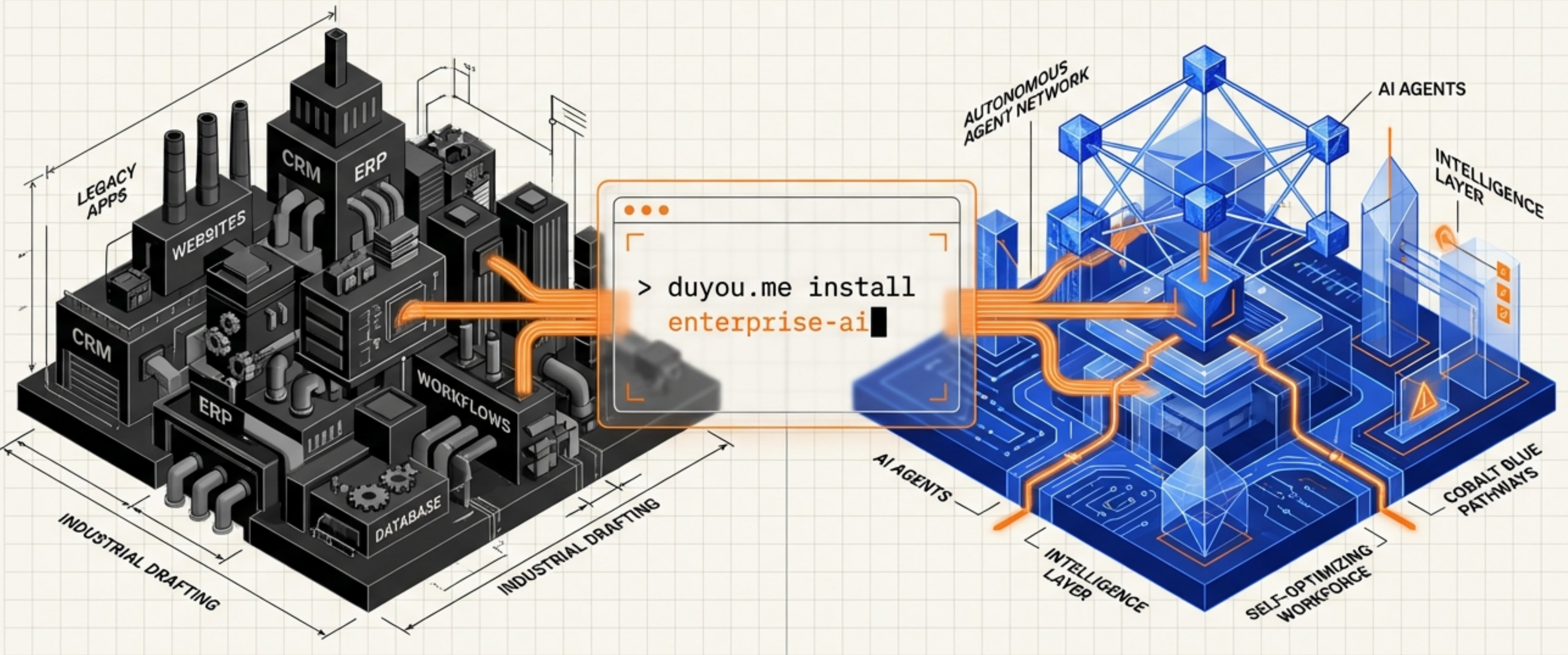

The AI Gap: Smart Agents, Incompatible Tools

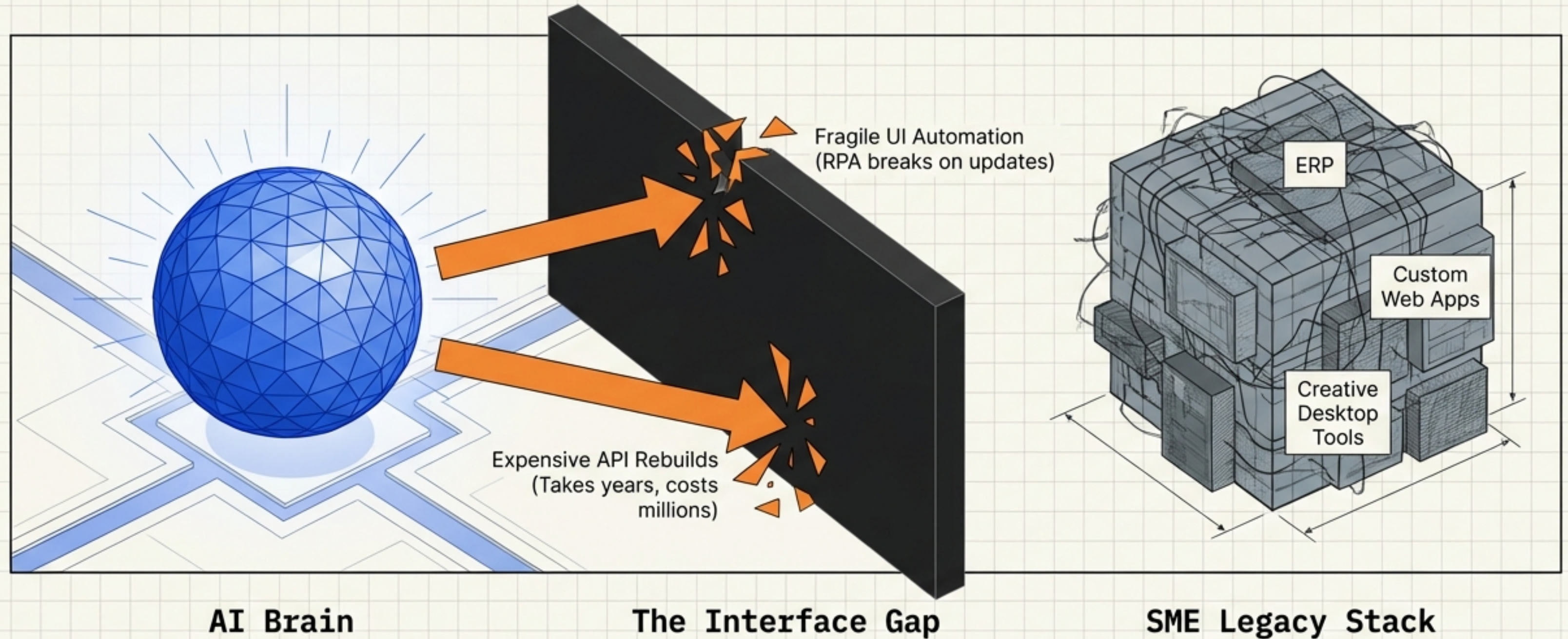

Modern AI agents can reason brilliantly, but they are trapped. They cannot effectively operate your existing legacy software, private web dashboards, or professional desktop tools.

Don't Rebuild. Translate.

Today's software serves humans. Tomorrow's users are Agents.

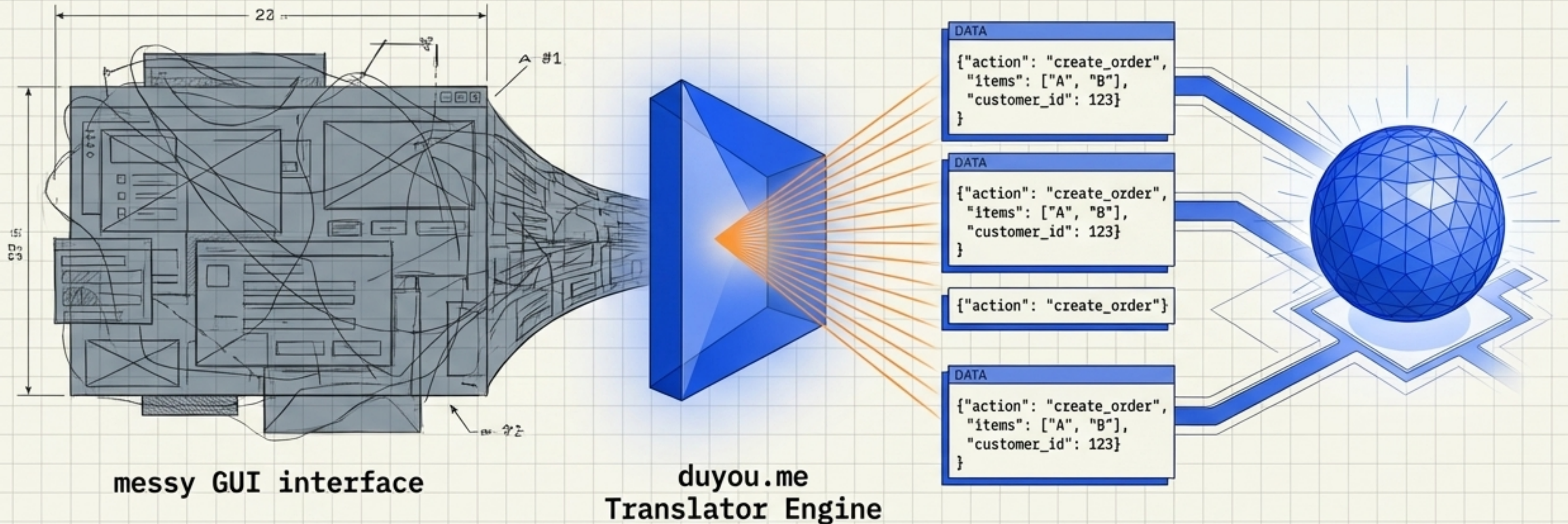

Instead of spending millions rebuilding your systems with native AI APIs, we transform your existing tools into structured, deterministic Command Line Interfaces (CLI).

4 Modules. 1 Complete AI Workforce.

The holistic, end-to-end architecture of the duyou.me ecosystem.

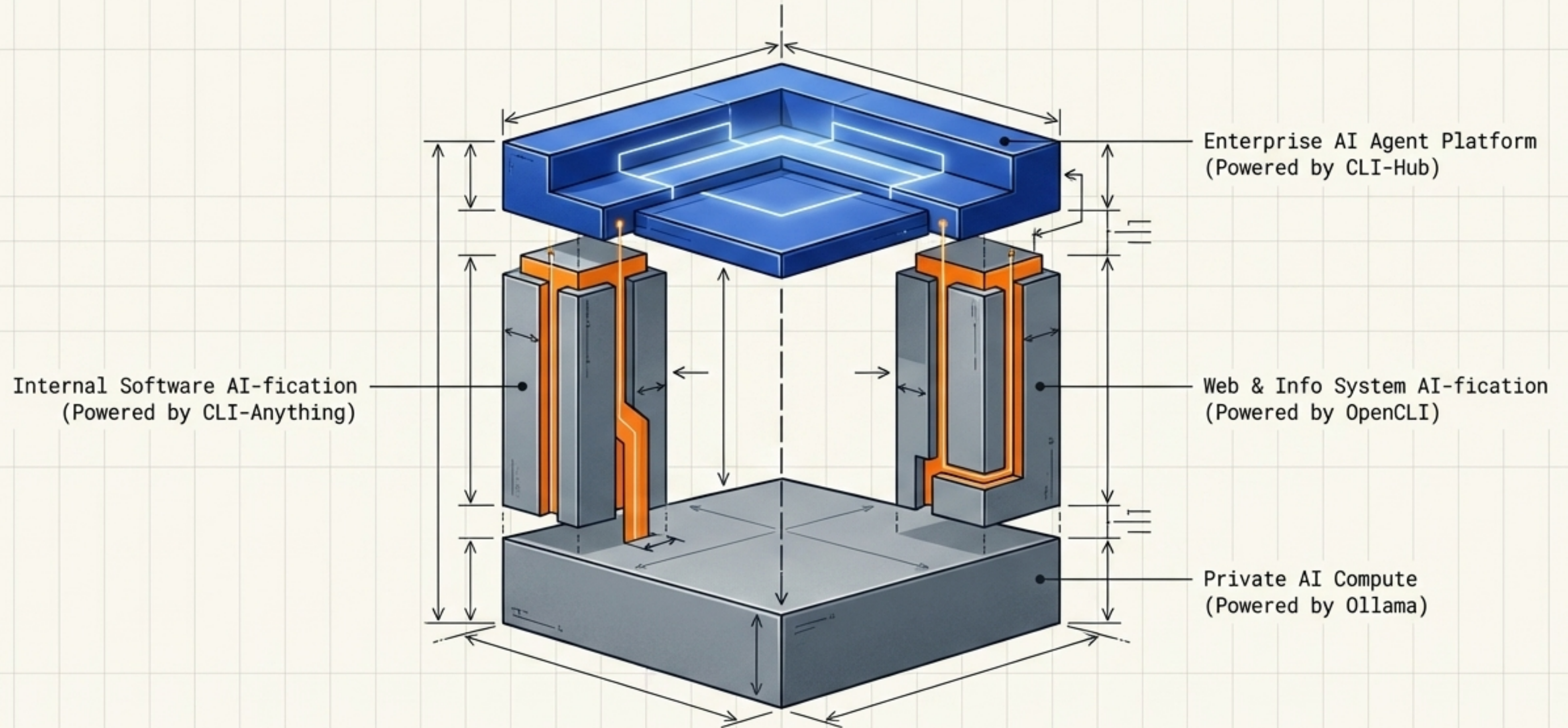

Module 1: Build Your Private AI Brain

True enterprise AI requires absolute data sovereignty.

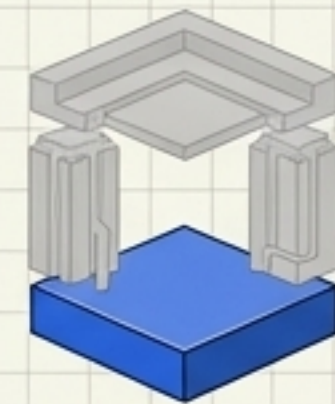

Private AI Compute
(Powered by Ollama)

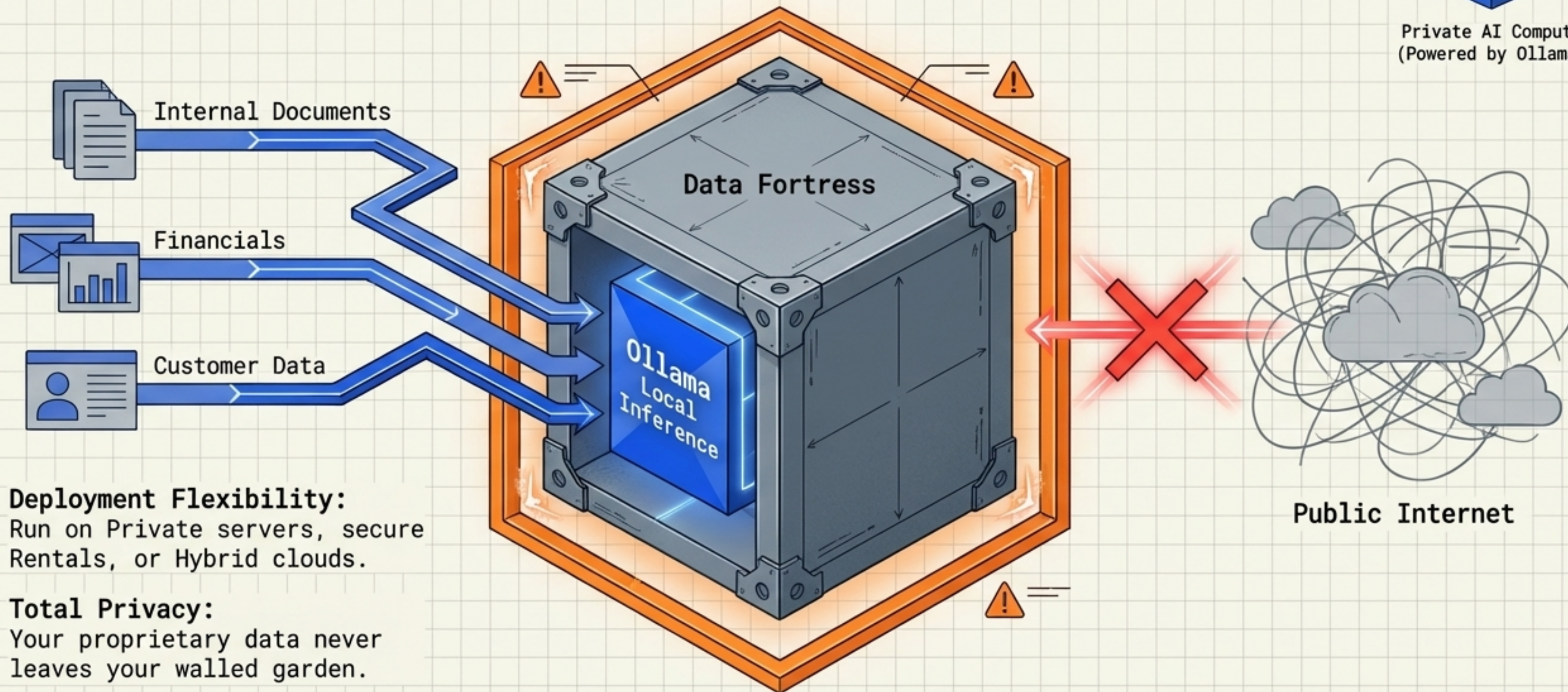

Deployment Flexibility:

Run on Private servers, secure Rentals, or Hybrid clouds.

Total Privacy:

Your proprietary data never leaves your walled garden.

Module 2: Making ALL Software Agent-Native

Convert complex professional software into deterministic AI-controllable endpoints using the CLI-Anything framework.

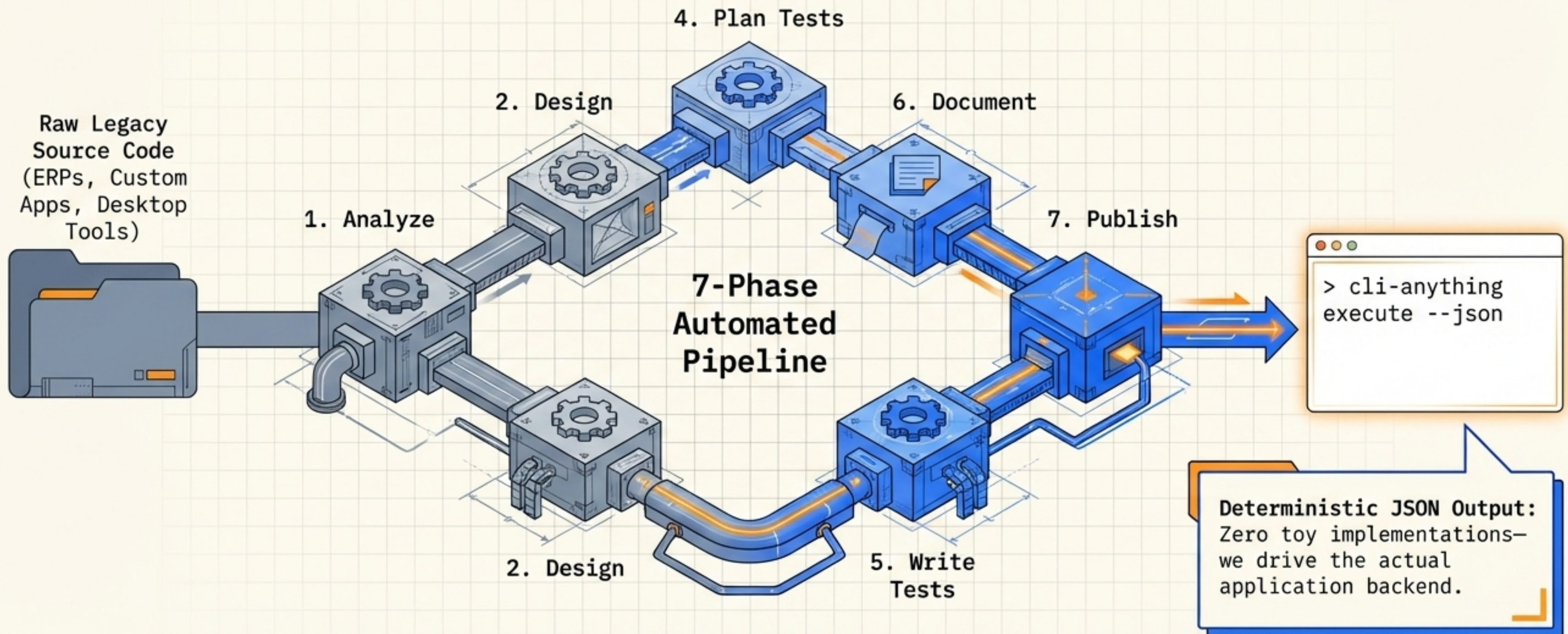
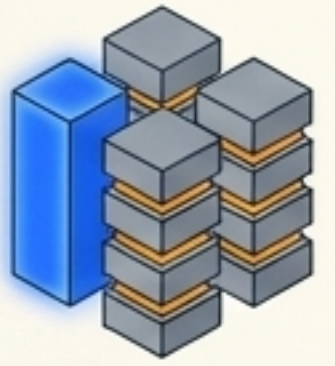

Module 3: Web-to-CLI Automation at Zero LLM Cost

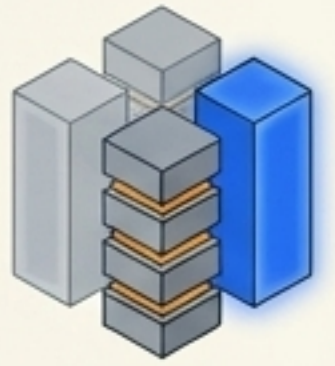

Transform any internal web dashboard, browser session, or Electron app into a highly reliable command using OpenCLI.

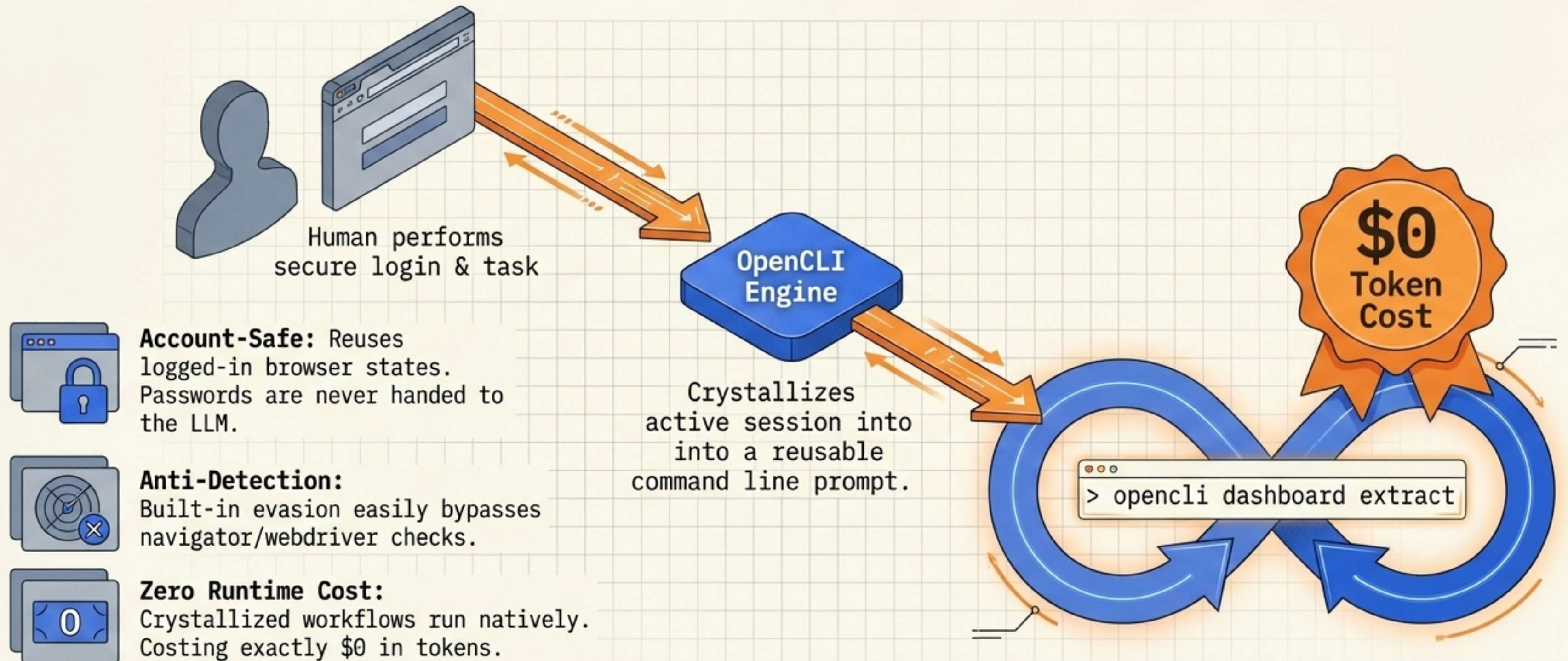

Why the Agent-Native CLI Strategy Wins

	Traditional RPA (UI Scraping)	Custom API Rebuild	The dyou.me CLI Strategy
Deployment Time	Months	Years	Days
Reliability	Fragile (Breaks on UI update) ❌	High	100% Deterministic ✓
Cost Profile	High Maintenance	Massive CapEx	Highly Cost-Effective ✓ (Zero Runtime Cost)
Legacy Support	Poor	Impossible	Universal ✓ (Works with anything)

Module 4: The Autonomous Orchestrator

A live, dynamic marketplace where AI agents discover and use tools to solve multi-step problems.

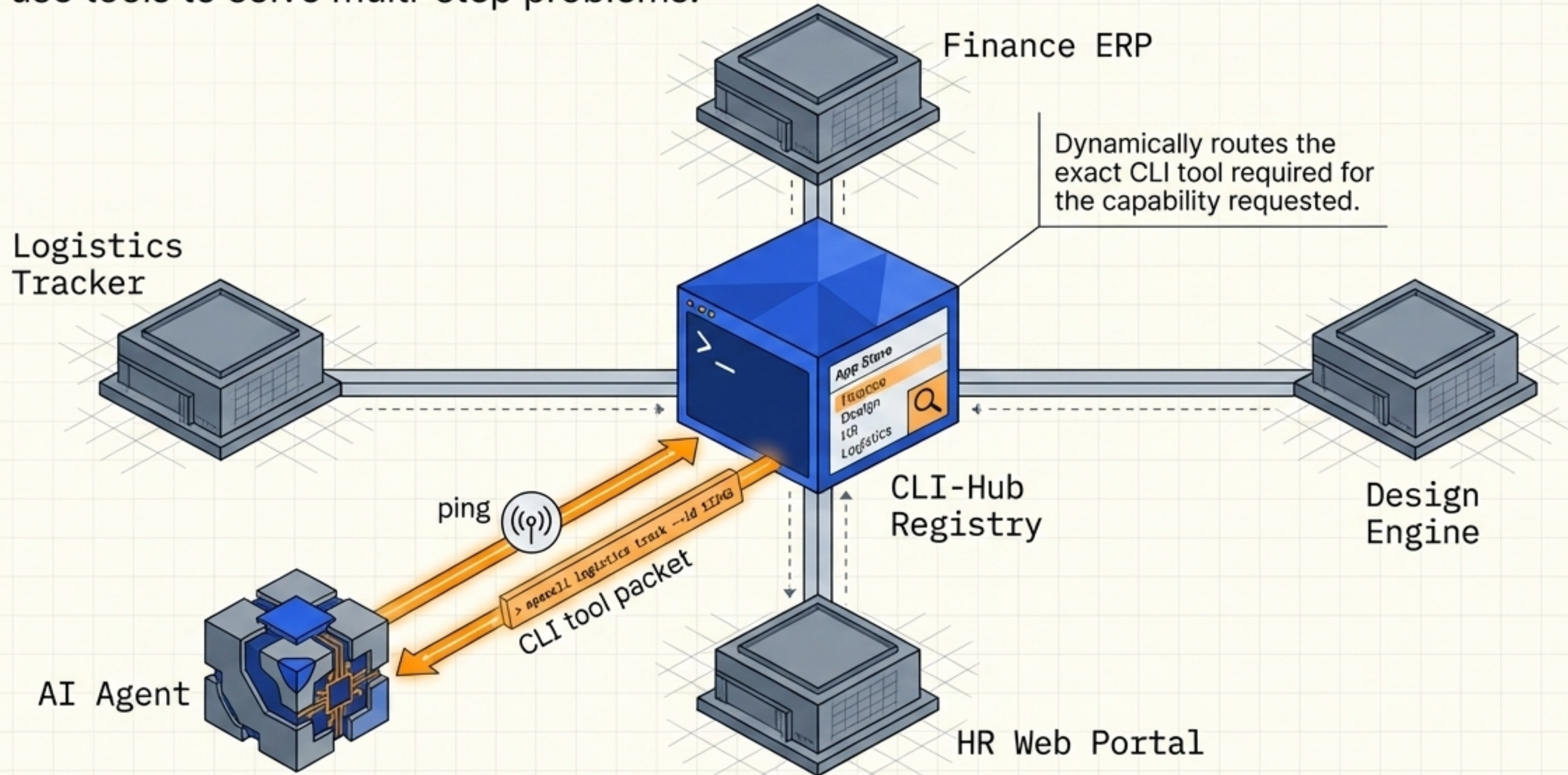
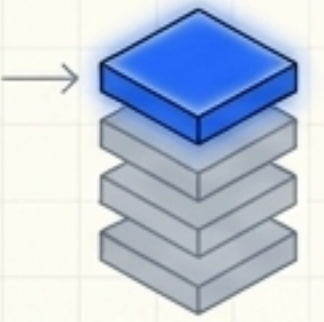

Zero-Shot Onboarding via AGENT.md

How does an AI immediately know how to use custom legacy software it has never seen before?

The Golden Key: Every CLI ships with a self-describing, machine-readable manual. The agent reads the constraints and executes flawlessly.

Extract Q3 Revenue
& Generate Report

AGENT.md

name: finance-erp-extract
description: Extracts quarterly revenue data.
parameters:
 quarter: string (e.g., Q1, Q2, Q3)
 format: json

```
{  
  "command": "finance-erp-extract",  
  "arguments": {  
    "quarter": "Q3",  
    "format": "json"  
  },  
  "status": "SUCCESS",  
  "data": {  
    "revenue_q3": 15240000,  
    "currency": "USD",  
    "report_id": "REP-12343-Q3"  
  }  
}
```

AI

Step 1: Agent Task

Step 2: Discovery

Step 3: Execution

Predictable. Reliable. 100% Deterministic.

By forcing AI to interact via structured commands, we eliminate hallucination.

2,130+

Multi-layered tests passed perfectly.

100% Pass Rate

Covering 16 major complex applications (ERP, Blender, GIMP, custom tools).

Native Auto-Recovery

System self-correction natively triggered if a command fails.

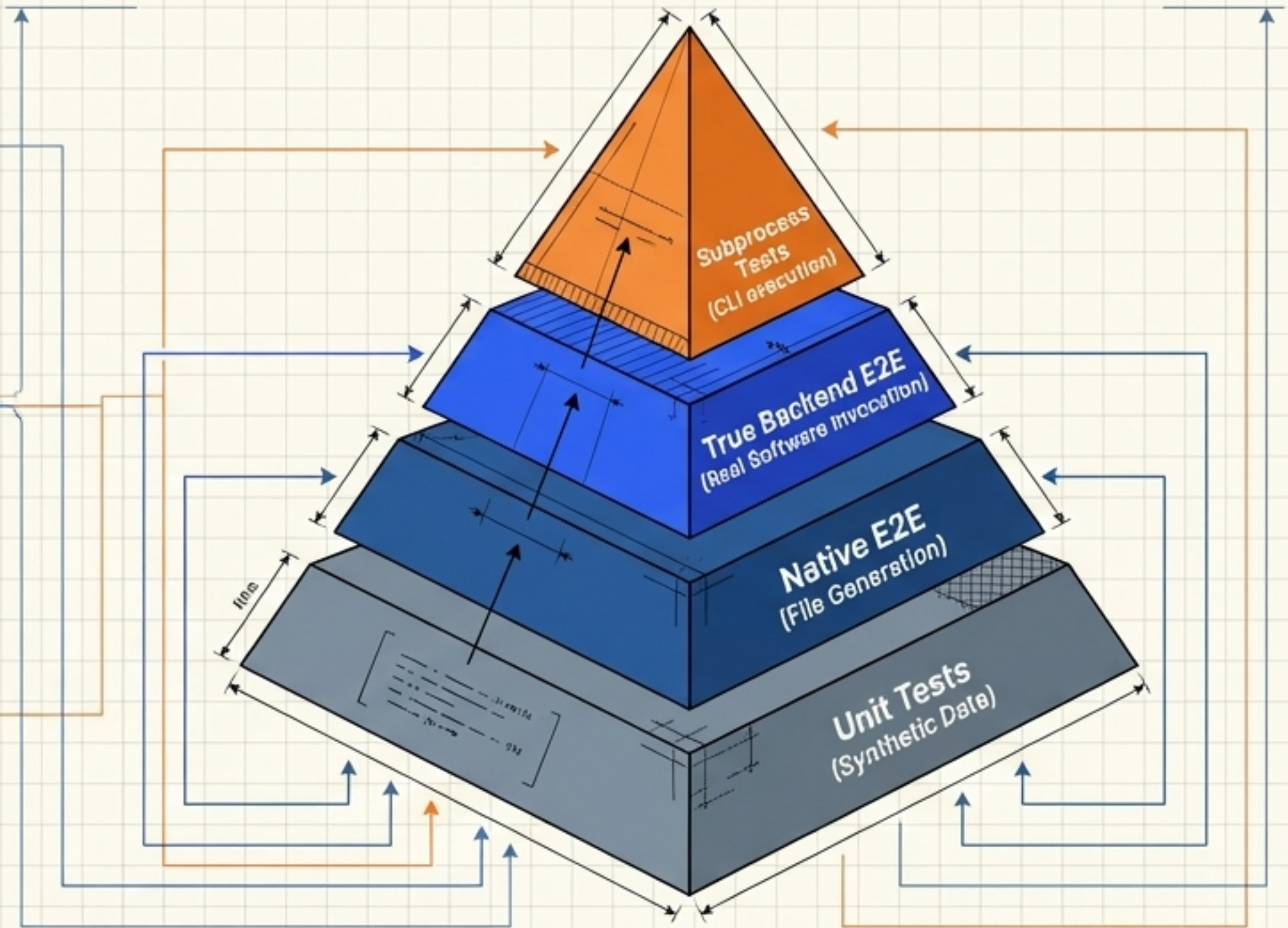

Your New AI Workforce in Motion

What used to take a human 3 days across multiple disjointed systems now takes an Agent 3 minutes.

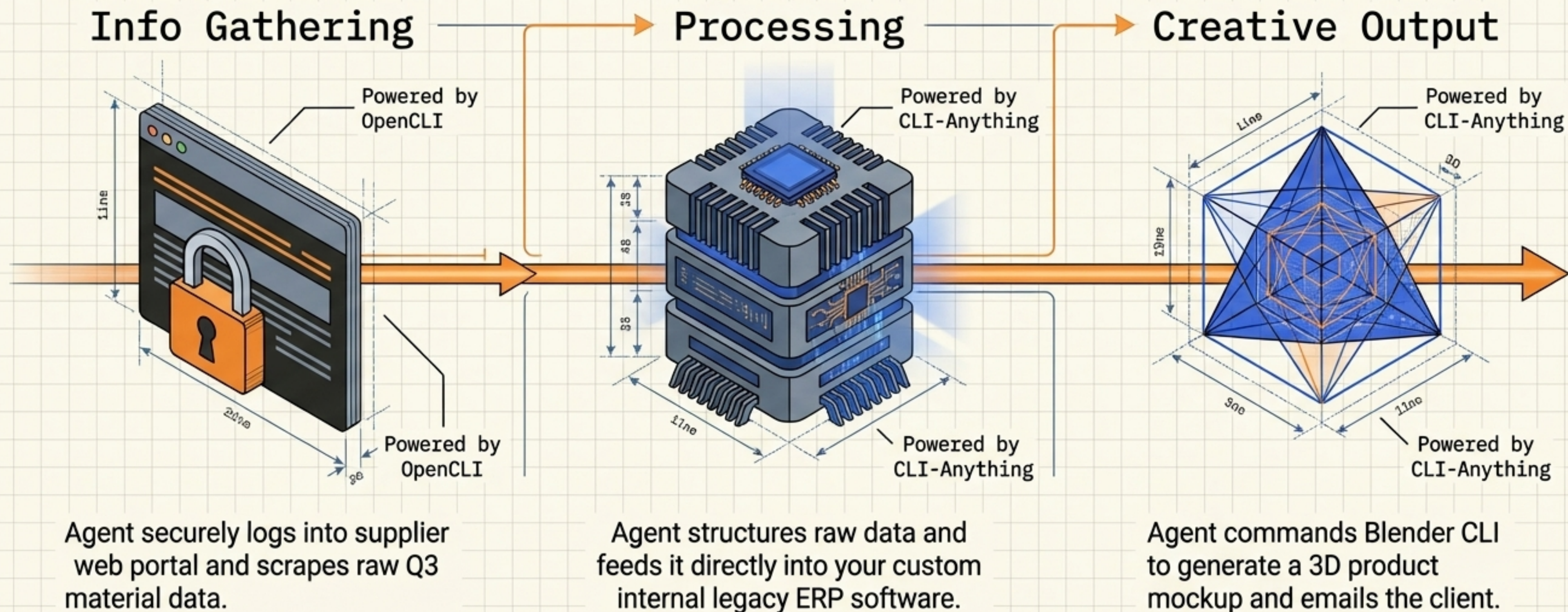

Zero Compromise on Security & Speed

Modernize your enterprise without risking your IP or disrupting daily operations.

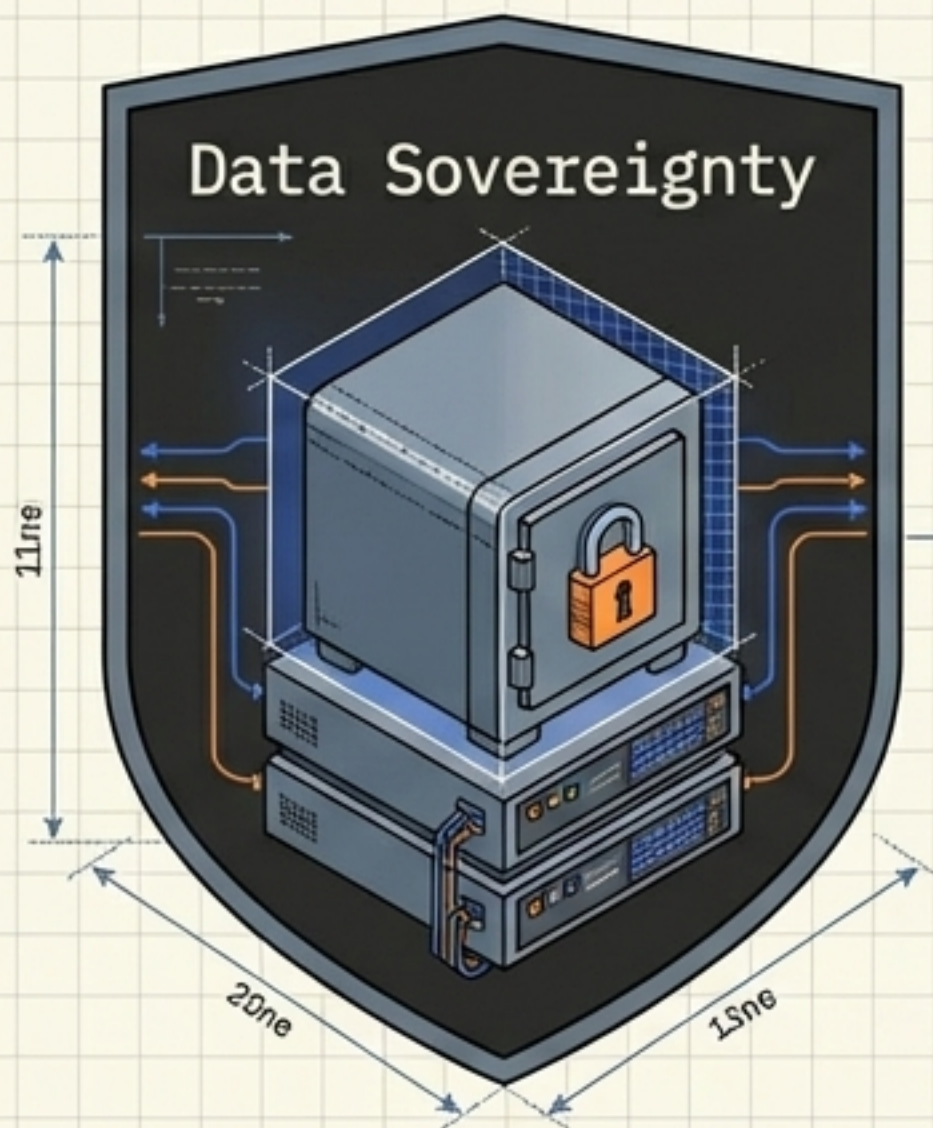

Private LLM compute ensures zero data leakage to public models. Your walled garden remains intact.

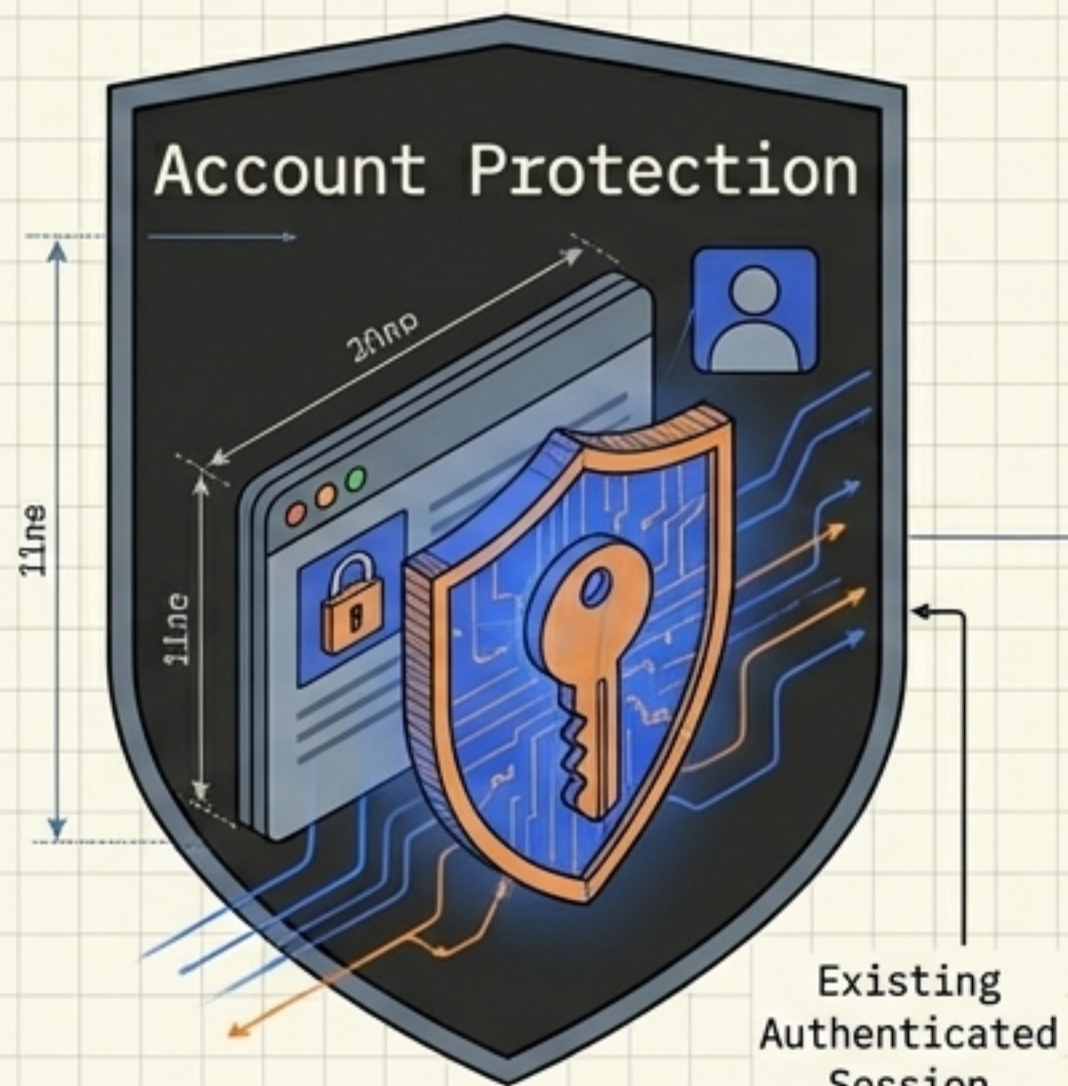

OpenCLI reuses existing authenticated browser sessions. Passwords are never exposed to the LLM.



Rapid deployment that wraps your systems. We do not disrupt or rewrite a line of your current legacy codebase.

The Universal Interface for the Age of AI

The businesses that win the next decade won't be the ones that tore down and rebuilt everything from scratch. They will be the ones that empowered their existing infrastructure.

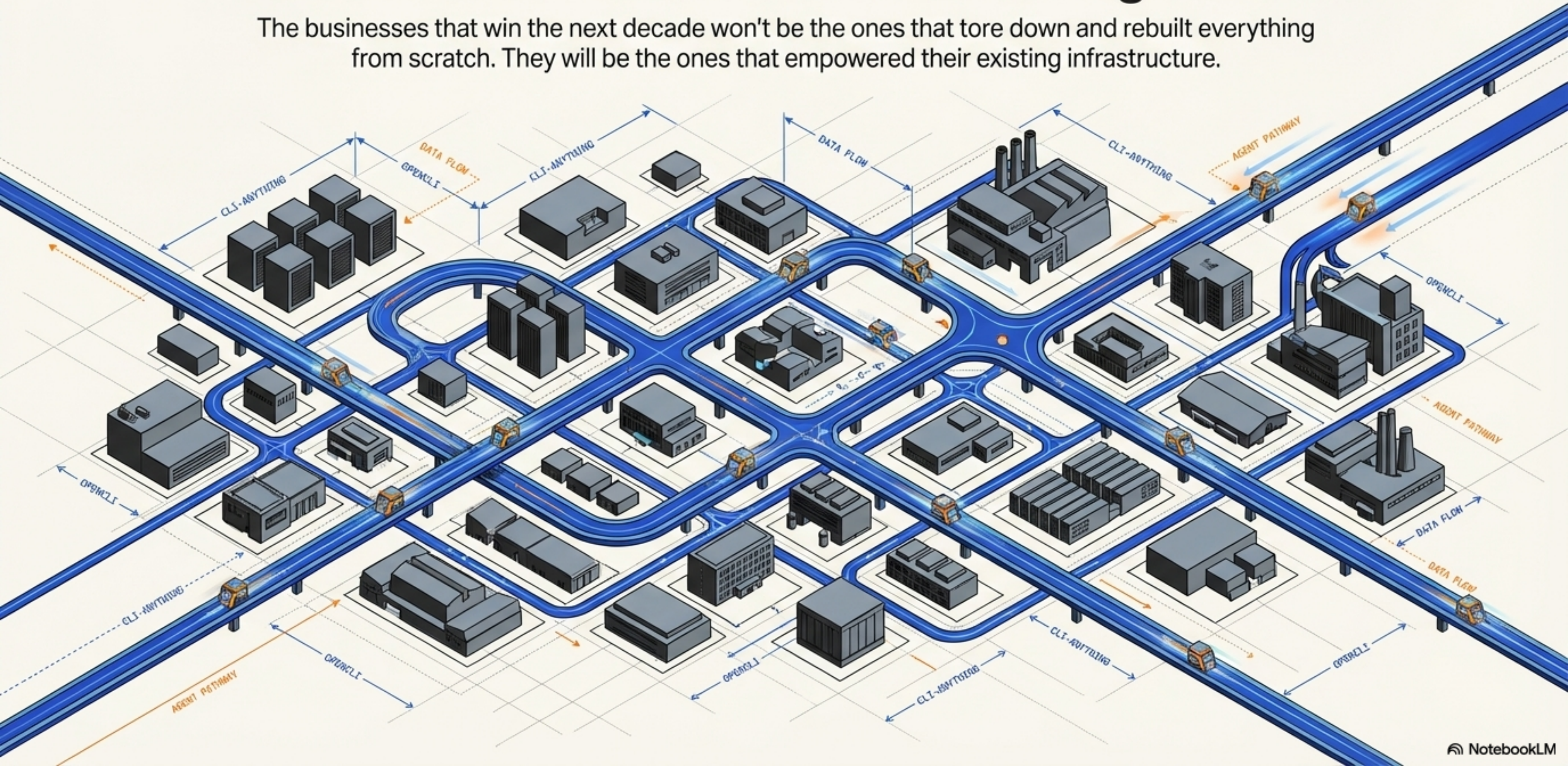

Step into the Agent-Native Era with duyou.me

Stop waiting for AI to adapt to your business. Let us build the bridge.

1. Schedule a free infrastructure assessment.
2. Identify your first 3 workflows for AI-fication.
3. Watch your agents execute via CLI in days, not months.



For contact and schedule contacts

duyou.me

```
> system ready_█
```